



CÔNG TY TNHH SẢN XUẤT THƯƠNG MẠI NHỰA CHÂU ÂU
EUROPEAN PLASTIC PRODUCTION TRADING CO., LTD



Product List & Technical Catalogue
**NHẬN SẢN XUẤT, GIA CÔNG SẢN PHẨM
THEO THƯƠNG HIỆU**



CÔNG TY TNHH SẢN XUẤT THƯƠNG MẠI NHỰA CHÂU ÂU
EUROPEAN PLASTIC PRODUCTION TRADING CO., LTD



ĐAU NƠI ĐỒNG HỒ NƯỚC
HOTLINE: 0903170009

Web: euplastic.net

BỘ KHOA HỌC VÀ CÔNG NGHỆ

CỤC SỞ HỮU TRÍ TUỆ



CỘNG HÒA XÃ HỘI CHỦ NGHĨA VIỆT NAM

Độc lập - Tự do - Hạnh phúc

GIẤY CHỨNG NHẬN ĐĂNG KÝ NHÃN HIỆU

Chủ Giấy chứng nhận: CÔNG TY TNHH SẢN XUẤT THƯƠNG MẠI NHỰA CHÂU ÂU
Số 68/8A Đường Trần Tấn, phường Tân Sơn Nhì, Quận Tân Phú, Tp. HCM

Cấp theo Quyết định số: /QĐ-SHTT, ngày:

Có hiệu lực từ ngày cấp đến hết 10 năm tính từ ngày nộp đơn (có thể gia hạn).



KT. CỤC TRƯỞNG
PHÓ CỤC TRƯỞNG





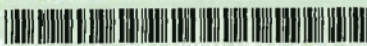







Trần Hữu Nam





CONTENTS / MỤC LỤC

	PHỤ KIỆN NỐI ỐNG HDPE BẰNG PHƯƠNG PHÁP SIẾT GIOĂNG EU PP COMPRESSION FITTING	06
	VAN NHỰA DỪNG CHO ỐNG HDPE & PPR PLASTIC BALL VALVE	10
	NẮP VAN TỶ CHÌM & HỘP ĐỒNG HỒ PLASTIC WATER VALVE COVER & WATER METER BOX	11
	ĐAI KHỞI THỦY DỪNG TRÍCH NƯỚC ỐNG HDPE, UPVC & PPR HDPE, UPVC & PPR CLAMP SADDLE	12
	PHỤ KIỆN HÀN ĐỐI ĐẦU HDPE PE BUTT FUSION FITTING	14
	PHỤ KIỆN HÀN ĐIỆN TRỞ ELECTROFUSION FITTING SERIES	18
	PHỤ KIỆN HÀN LỒNG SOCKET JOINT SERIES	23
	MÁY HÀN EU BUTT FUSION WELDING MACHINE	27
	ỐNG HDPE CẤP/THOÁT	31
	VAN CỔNG GANG, PHỤ KIỆN GANG	33
	ĐỒNG HỒ NƯỚC	35
	ỐNG GÂN XOẮN HDPE LÒN ĐIỆN	36



PHỤ KIỆN NỐI ỐNG HDPE
BẰNG PHƯƠNG PHÁP SIẾT GIOẰNG
EU PP COMPRESSION FITTING





NỐI THẲNG COUPLING

Code	D	DN
NT20	20	15
NT25	25	20
NT32	32	25
NT40	40	32
NT50	50	40
NT63	63	50
NT75	75	65
NT90	90	80
NT110	110	100



NỐI REN TRONG FEMALE ADAPTOR

Code	DXG	DN	PN	Z
NRT20.1/2	20x1/2"	15x15	16	16
NRT25.1/2	25x1/2"	20x15	16	16
NRT25.3/4	25x3/4"	20x20	16	18
NRT32.1	32x1"	25x25	16	20
NRT40.1-1/4	40x1-1/4"	32x32	16	25
NRT50.1-1/2	50x1-1/2"	40x40	16	27
NRT63.2	63x2"	50x50	16	30
NRT75.2-1/2	75x2-1/2"	65x65	10	33
NRT90.3	90x3"	80x80	10	35
NRT110.4	110x4"	100x100	10	40



NỐI GIẢM REDUCING COUPLING

Code	DXD1	DN	PN	Z
NG25-20	25 x 20	20	16	3
NG32-20	32 x 20	25	16	3
NG32-25	32 x 25	25	16	4
NG40-20	40 x 20	32	16	4
NG40-25	40 x 25	32	16	4
NG40-32	40 x 32	32	16	5
NG50-20	50 x 20	40	16	4
NG50-25	50 x 25	40	16	4
NG50-32	50 x 32	40	16	5
NG50-40	50 x 40	40	16	5
NG63-25	63 x 25	50	16	4
NG63-32	63 x 32	50	16	4
NG63-40	63 x 40	50	16	5
NG63-50	63 x 50	50	16	8
NG75-40	75 x 40	65	16	8
NG75-50	75 x 50	65	10	8
NG75-63	75 x 63	65	10	8
NG90-63	90 x 63	80	10	8
NG90-75	90 x 75	80	10	10
NG110-75	110 x 75	100	10	10
NG110-90	110 x 90	100	10	10



NỐI REN NGOÀI MALE ADAPTOR

Code	DXG	DN	PN
NRN20.1/2	20x1/2"	15x15	16
NRN20.3/4	20x3/4"	15x20	16
NRN20.1	20x1"	15x25	16
NRN25.1/2	25x1/2"	20x15	16
NRN25.3/4	25x3/4"	20x20	16
NRN25.1	25x1"	20x25	16
NRN32.3/4	32x3/4"	25x20	16
NRN32.1	32x1"	25x25	16
NRN32.1-1/4	32x1-1/4"	25x32	16
NRN40.1	40x1"	32x25	16
NRN40.1/4	40x1-1/4"	32x32	16
NRN40.1/2	40x1-1/2"	32x40	16
NRN50.1	50x1"	40x25	16
NRN50.1-1/4	50x1-1/4"	40x32	16
NRN50.1-1/2	50x1-1/2"	40x50	16
NRN50.2	50x2"	40x40	16
NRN63.1-1/4	63x1-1/4"	50x32	16
NRN63.1-1/2	63x1-1/2"	50x40	16
NRN63.2	63x2"	50x50	16
NRN75.2-1/2	75x2-1/2"	65x65	10
NRN90.3	90x3"	80x80	10
NRN110.4	110x4"	100x100	10

PHỤ KIỆN NỐI ỐNG HOPE
BẢNG PHƯƠNG PHÁP SÉT ỐNG
EU PP COMPRESSION FITTING

VAN NHỰA DÙNG CHO
ỐNG HDPE & PPR
PLASTIC BALL VALVE

NẠP VAN TỶ CHỈM & HỘ ĐỘNG HỒ
PLASTIC WATER VALVE COVER &
WATER METER BOX

ĐAI KHỚP THUY CHỈM ỐNG
UPVC & HDPE
UPVC & HDPE CLAMP SADDLE

PHỤ KIỆN HẠN ĐỐI ĐẦU HOPE
PE BUTT FUSION FITTING

PHỤ KIỆN HẠN ĐIỆN TRỞ
ELECTROFUSION FITTING SERIES

PHỤ KIỆN HẠN LÔNG
SOCKET BOND SERIES

MÁY HẠN
EU BUTT FUSION WELDING MACHINE

ỐNG HOPE CÁP/THOÁT

VAN CÔNG GANG
PHỤ KIỆN GANG

ĐỒNG HỒ NƯỚC

ỐNG GÁN XOÀN
HOPE LƯỚI ĐIỆN

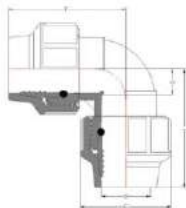

CÚT ELBOW

Code	D	DN	PN	Z
C20	20	15	16	12
C25	25	20	16	20
C32	32	25	16	23
C40	40	32	16	25
C50	50	40	16	27
C63	63	50	16	34
C75	75	65	10	46
C90	90	80	10	48
C110	110	100	10	65

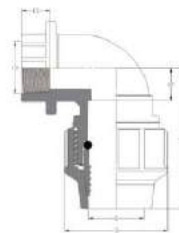

CÚT REN TRONG FEMALE ELBOW

Code	DXG	DN	PN	Z
CRT20.1/2	20x1/2"	15x15	16	13
CRT20.3/4	20x3/4"	20x15	16	16
CRT25.3/4	25x3/4"	20x20	16	16
CRT32.1	32x1"	25x25	16	22
CRT40.1-1/4	40x1-1/4"	32x32	16	27
CRT50.1-1/2	50x1-1/2"	40x40	16	28
CRT63.2	63x2"	50x50	16	37

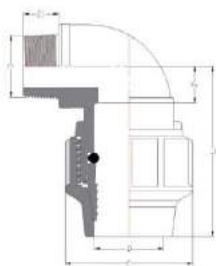

CÚT REN NGOÀI MALE ELBOW

Code	DXG	DN	PN	Z	Z1
CRN20.1/2	20x1/2"	15x15	16	12	16
CRN20.3/4	20x3/4"	20x15	16	12	18
CRN25.3/4	25x3/4"	20x20	16	20	18
CRN32.1	32x1"	25x25	16	23	20
CRN40.1-1/4	40x1-1/4"	32x32	16	25	25
CRN50.1-1/2	50x1-1/2"	40x40	16	27	27
CRN63.2	63x2"	50x50	16	34	30

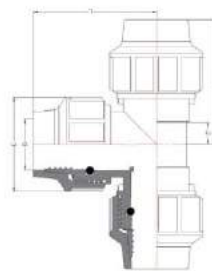

TÊ TEE

Code	D	DN	PN	Z
T20	20	15	16	12
T25	25	20	16	20
T32	32	25	16	23
T40	40	32	16	25
T50	50	40	16	27
T63	63	50	16	34
T75	75	65	10	46
T90	90	80	10	18
T110	110	100	10	65



TÊ REN TRONG FEMALE TEE

Code	DXG	DN	PN	Z	Z1
TRT20.1/2	20x1/2"	15x15	16	12	16
TRT20.3/4	20x3/4"	20x15	16	12	18
TRT25.3/4	25x3/4"	20x20	16	20	18
TRT32.1	32x1"	25x25	16	23	20
TRT40.1-1/4	40x1-1/4"	32x32	16	25	25
TRT50.1-1/2	50x1-1/2"	40x40	16	27	27
TRT63.2	63x2"	50x50	16	34	30



TÊ REN NGOÀI / **MALE TEE**

Code	D	DN	PN	Z
TRN20.1/2	20x1/2"	15x15	16	12
TRN20.3/4	20x3/4"	20x15	16	12
TRN25.3/4	25x3/4"	20x20	16	20
TRN32.1	32x1"	25x25	16	23
TRN40.1-1/4	40x1-1/4"	32x32	16	25
TRN50.1-1/2	50x1-1/2"	40x40	16	27
TRN63.2	63x2"	50x50	16	34



TÊ GIẢM / **REDUCING TEE**

Code	D	DN	PN	Z
TG25-20	25x25x20	15	16	13
TG25-20	25x20x25	20	16	16
TG32-20	32x20x32	25	16	22
TG32-25	32x25x32	25	16	22
TG40-20	40x20x40	32	16	27
TG40-25	40x25x40	32	16	27
TG40-32	40x32x40	32	16	27
TG50-25	50x25x50	40	16	28
TG50-32	50x32x50	40	16	28
TG50-40	50x40x50	40	16	28
TG63-32	63x32x60	50	16	37
TG63-40	63x40x63	50	16	37
TG63-50	63x50x60	50	16	37
TG75-50	75x50x74	65	10	47
TG75-63	75x63x75	65	10	47
TG90-63	90x63x90	80	10	55
TG90-75	90x75x90	80	10	55
TG110-90	110x90x110	100	10	66

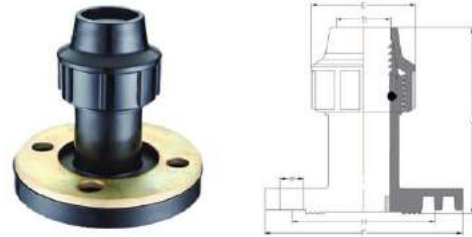

NÓI MỘT ĐẦU BÍCH / **FLANGE**

Code	D	DN	PN	F	H
NDB50.1-1/2	50x1-1/2	40x40	10	152	110
NDB63.2	63x2	50x50	16	164	125
NDB75.2-1/2	75x2-1/2"	65x65	16	184	145
NDB90.3	90x3"	80x80	10	200	160
NDB110.4	110x4	100x100	10	220	180



NÚT BỊT / **PLUG**

Code	D	DN	PN	Z
NB20	20	15	16	50
NB25	25	20	16	60
NB32	32	25	16	80
NB40	40	32	16	86
NB50	50	40	16	98
NB63	63	50	16	115
NB75	75	65	10	145
NB90	90	80	10	155
NB110	110	100	10	200

PHỤ KIỆN NỐI ỐNG HOPE
BẢNG THÔNG SỐ SẢN PHẨM
DI: PP-COMPRESSION FITTING

VAN NHỰA DÙNG CHO
ỐNG HDPE & PPR
PLASTIC WATER VALVE
PLASTIC BALL VALVE

MÁY NẤY CHÌM & LẬP ỐNG HDPE
PLASTIC WATER VALVE COVER &
WATER METER BOX

ĐAI KÈO THUYẾT CHO ỐNG
UPVC & HDPE
UPVC & HDPE CLAMP SADDLE

PHỤ KIỆN HÀN ĐỐI ĐẦU HOPE
PE-BIT TUBING FITTING

PHỤ KIỆN HÀN ĐIỆN TRỞ
ELECTROFUSION FITTING SERIES

PHỤ KIỆN HÀN LỒNG
SOCKET JAWB SERIES

MÁY HÀN
PE-BIT FUSION WELDING MACHINE

ỐNG HOPE CẤP/THOÁT

VAN CÔNG BĂNG
PHỤ KIỆN GĂNG

ĐỒNG HỒ NƯỚC

ỐNG GÂY XÒAN
HOPE LƯỚI ĐIỆN



VAN NHỰA DÙNG CHO ỐNG HDPE VÀ PPR

PLASTIC BALL VALVE



PLASTIC BALL VALVE

	20	25	32	40	50	63
Size(mm)	20	25	32	40	50	63
A (mm)	20	25	32	40	50	63
B (mm)	150	170	195	260	295	363
T (mm)	65	80	105	134	134	162

NẮP VAN TY CHÌM & HỘP ĐỒNG HỒ

PLASTIC WATER VALVE COVER & WATER METER BOX



HỘP ĐỒNG HỒ WATER METER BOX

THÀNH PHẦN/PART	CHẤT LIỆU/ MATERIAL
Nắp/ Upside cover	Nhựa PP hoặc PE/ Polypropylen or Polythene
Thân / body	Nhựa PP hoặc PE/ Polypropylen or Polythene
Đáy/ Under cover	Nhựa PP hoặc PE/ Polypropylen or Polythene
Vít/ Bolt	Kẽm/ Inox



HỘP BẢO VỆ ĐỒNG HỒ CHẤT LIỆU INOX



NẮP ĐẠY VAN TY CHÌM PLASTIC WATER VALVE COVER

Code	D	H
NAP 160	160	45



HỘP BẢO VỆ ĐỒNG HỒ HDPE



ĐAI KHỞI THỦY CHO ỐNG UPVC VÀ HDPE
EU PP REINFORCED CLAMP SADDLES

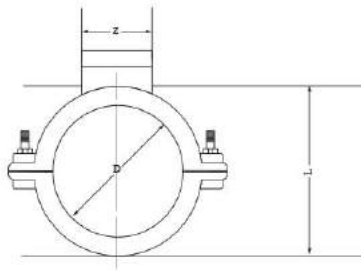

ĐAI KHỚP THỦY CLAMP SADDLE

Quy cách	Quy cách	Quy cách	Áp lực
32mm x 1/2"	90mm x 1 1/2"	160mm x 1 1/2"	PN 16
32mm x 3/4"	90mm x 2"	160mm x 2"	PN 16
32mm x 1"	110mm x 1/2"	180mm x 1/2"	PN 16
40mm x 1/2"	110mm x 3/4"	180mm x 3/4"	PN 16
40mm x 3/4"	110mm x 1"	180mm x 2"	PN 16
40mm x 1"	110mm x 1 1/4"	200mm x 1/2"	PN 16
50mm x 1/2"	110mm x 1 1/2"	200mm x 3/4"	PN 16
50mm x 3/4"	110mm x 2"	200mm x 1"	PN 16
50mm x 1"	125mm x 1/2"	200mm x 1 1/4"	PN 16
50mm x 1 1/4"	125mm x 3/4"	200mm x 1 1/2"	PN 16
63mm x 1/2"	125 m x 1"	200mm x 2"	PN 16
63mm x 3/4"	125 m x 1 1/4"	225mm x 1/2"	PN 16
63mm x 1"	125 m x 1 1/2"	225mm x 3/4"	PN 16
63mm x 1 1/4"	125 m x 2"	225mm x 1"	PN 16
63mm x 1 1/2"	140mm x 1/2"	225mm x 1 1/4"	PN 16
75mm x 1/2"	140mm x 3/4"	225mm x 1 1/2"	PN 16
75mm x 3/4"	140mm x 1"	225mm x 2"	PN 16
75mm x 1"	140mm x 1.1/4"	250mm x 1 1/2"	PN 16
75mm x 1 1/4"	140mm x 1.1/2"	250mm x 2"	PN 16
75mm x 1 1/2"	140mm x 2"	315mm x 3/4"	PN 16
90mm x 1/2"	160mm x 1/2"	315mm x 1"	PN 16
90mm x 3/4"	160mm x 3/4"	315mm x 1-1/2"	PN 16
90mm x 1"	160mm x 1"	315mm x 2"	PN 16
90mm x 1 1/4"	160mm x 1 1/4"		PN 16

ĐAI KHỚP THỦY CLAMP SADDLE

Quy cách	Quy cách	Quy cách	Áp lực
49mm x 1/2"	120mm x 1 1/2"	200mm x 1 1/4"	PN 16
49mm x 3/4"	120mm x 2"	200mm x 1 1/2"	PN 16
49mm x 1"	125mm x 1/2"	200mm x 2"	PN 16
60mm x 1/2"	125mm x 3/4"	216mm x 1/2"	PN 16
60mm x 3/4"	125 m x 1"	216mm x 3/4"	PN 16
60mm x 1"	125 m x 1 1/4"	216mm x 1"	PN 16
60mm x 1 1/4"	125 m x 1 1/2"	216mm x 1 1/4"	PN 16
60mm x 1 1/2"	125 m x 2"	216mm x 1 1/2"	PN 16
75mm x 1/2"	140mm x 1/2"	216mm x 2"	PN 16
75mm x 3/4"	140mm x 3/4"	220mm x 1/2"	PN 16
75mm x 1"	140mm x 1"	220mm x 3/4"	PN 16
75mm x 1 1/4"	140mm x 1.1/4"	220mm x 1"	PN 16
75mm x 1 1/2"	140mm x 1.1/2"	220mm x 1 1/4"	PN 16
90mm x 1/2"	140mm x 2"	220mm x 1 1/2"	PN 16
90mm x 3/4"	168mm x 1/2"	220mm x 2"	PN 16
90mm x 1"	168mm x 3/4"	225mm x 1/2"	PN 16
90mm x 1 1/4"	168mm x 1"	225mm x 3/4"	PN 16
90mm x 1 1/2"	168mm x 1 1/4"	225mm x 1"	PN 16
90mm x 2"	168mm x 1 1/2"	225mm x 1 1/4"	PN 16
114mm x 1/2"	168mm x 2"	225mm x 1 1/2"	PN 16
114mm x 3/4"	177mm x 1/2"	225mm x 2"	PN 16
114mm x 1"	177mm x 3/4"	250mm x 1 1/2"	PN 16
114mm x 1 1/4"	177mm x 2"	250mm x 2"	PN 16
114mm x 1 1/2"	180mm x 1/2"	315mm x 3/4"	PN 16
114mm x 2"	180mm x 3/4"	315mm x 1"	PN 16
120mm x 1/2"	180mm x 2"	315mm x 1-1/2"	PN 16
120mm x 3/4"	200mm x 1/2"	315mm x 2"	PN 16
120mm x 1"	200mm x 3/4"		PN 16
120mm x 1 1/4"	200mm x 1"		

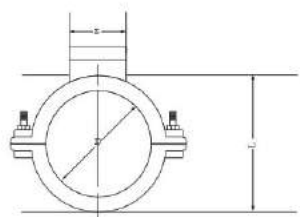

ĐAI KHỚP THỦY REN ĐỒNG CLAMP SADDLE WITH BRASS INSERT

Quy cách	Quy cách	Quy cách	Áp lực
49mm x 3/4"	110mm x 3/4"	168mm x 3/4"	PN 16
50mm x 3/4"	114mm x 3/4"	177mm x 3/4"	PN 16
60mm x 3/4"	120mm x 3/4"	180mm x 3/4"	PN 16
63mm x 3/4"	125mm x 3/4"	200mm x 3/4"	PN 16
75mm x 3/4"	140mm x 3/4"	220mm x 3/4"	PN 16
90mm x 3/4"	160mm x 3/4"	225mm x 3/4"	PN 16

PHỤ KIỆN NỐI ỐNG HỢP CHẤT
BẢNG THÔNG SỐ PHÁP SÉT GIÓNG
DI / PP COMPRESSION FITTING

VAN NHỰA DÙNG CHO
ỐNG HDPE & PPR
PLASTIC BALL VALVE

NẮP WATY CHIM & HỘP ĐỒNG HỒ
WATER METER COVER &
WATER METER BOX

ĐAI KHỚP THỦY CHỐNG ĐỔNG
UPVC & HDPE
UPVC L IPE CLAMP SADDLE

PHỤ KIỆN HẠN ĐỐI ĐẦU HỢP CHẤT
PEBIT FUSION FITTING

PHỤ KIỆN HẠN ĐIỆN TRỞ
ELECTROFUSION FITTING SERIES

PHỤ KIỆN HẠN LỖNG
SOCKET JAWT SERIES

MÁY HÀN HỘP
DI UNIT FUSION WELDING MACHINE

ỐNG HỢP CHẤT CẤP/THOÁT

VAN CÔNG ĐĂNG
PHỤ KIỆN CÔNG ĐĂNG

ĐỒNG HỒ NƯỚC

ỐNG GÂY XÒAN
HỘP LƯỚI ĐIỆN



PHỤ KIỆN HÀN ĐỐI ĐẦU HDPE
PE BUTT FUSION FITTING

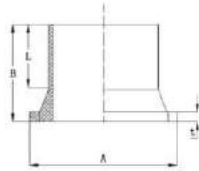

MẶT BÍCH FLANGE ADAPTOR

Code	Size (mm)	PN	PN	PN	B	t	A
BH63PN10	75	10	12.5	16	93	14	102
BH75PN10	75	10	12.5	16	101	10	122
BH90PN10	90	10	12.5	16	125	10	138
BH110PN10	110	10	12.5	16	95	16	147
BH125PN10	125	10	12.5	16	136	18	156
BH140PN10	140	10	12.5	16	103	17	178
BH160PN10	160	10	12.5	16	126	15	212
BH180PN10	180	10	12.5	16	128	15	212
BH200PN10	200	10	12.5	16	123	20	268
BH225PN10	225	10	12.5	16	126	21	268
BH250PN10	250	10	12.5	16	145	24	310
BH280PN10	280	10	12.5	16	158	29	320
BH315PN10	315	10	12.5	16	164	32	370
BH355PN10	355	10	12.5	16	182	38	430
BH400PN10	400	10	12.5	16	190	38	483
BH450PN10	450	10	12.5	16	175	38	520
BH500PN10	500	10	12.5	16	214	50	585
BH560PN10	560	10	12.5	16	175	41	685
BH630PN10	630	10	12.5	16	228	55	685
BH710PN10	710	10	12.5	16	232	62	810
BH800PN10	800	10	12.5	16	228	56	920
BH900PN10	900	10	12.5	16	220	60	990
BH1000PN10	1000	10	12.5	16	220	60	1090
BH1200PN10	1200	10	12.5	16	140	60	1037
BH1200PN10	1400	10	12.5	16	140	60	1524

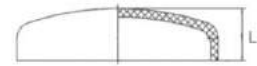

NÚT BỊT BUTT FUSION PLUG

Code	DN	DN	PN	PN	E
HBN110	110	10	12.5	16	99
HBN125	125	10	12.5	16	114
HBN140	140	10	12.5	16	126
HBN160	160	10	12.5	16	125
HBN180	180	10	12.5	16	146
HBN200	200	10	12.5	16	129
HBN225	225	10	12.5	16	142
HBN250	250	10	12.5	16	132
HBN280	280	10	12.5	16	154
HBN315	315	10	12.5	16	168
HBN355	355	10	12.5	16	135
HBN400	400	10	12.5	16	140
HBN450	450	10	12.5	16	145
HBN500	500	10	12.5	16	155
HBN560	560	10	12.5	16	165
HBN630	630	10	12.5	16	168
HBN710	710	10	12.5	16	220
HBN800	800	10	12.5	16	240
HBN1000	1000	10	12.5	16	280

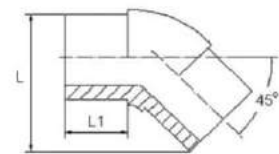

CHÈCH 45° BUTT FUSION ELBOW 45°

Code	Size (mm)	PN	PN	PN
CHH75	75x45	10	12.5	16
CHH90	90x45	10	12.5	16
CHH110	110x45	10	12.5	16
CHH125	125x45	10	12.5	16
CHH145	145x45	10	12.5	16
CHH160	160x45	10	12.5	16
CHH180	180x45	10	12.5	16
CHH200	200x45	10	12.5	16
CHH225	225x45	10	12.5	16
CHH250	250x45	10	12.5	16

CHÈCH 45° BUTT FUSION ELBOW 45°

Code	Size (mm)	PN	PN	PN
CHH280	280x45	10	12.5	16
CHH315	315x45	10	12.5	16
CHH355	355x45	10	12.5	16
CHH400	400x45	10	12.5	16
CHH450	450x45	10	12.5	16
CHH500	500x45	10	12.5	16
CHH560	560x45	10	12.5	16
CHH630	630x45	10	12.5	16
CHH710	710x45	10	12.5	16
CHH800	800x45	10	12.5	16

PHỤ KIỆN NỐI ỐNG HDPE
BẢNG THÔNG SỐ KỸ THUẬT
DI: PP COMPRESSION FITTING

VAN NHỰA DÙNG CHO
ỐNG HDPE & PPR
PLASTIC BALL VALVE

NẮP NHỰA DÙNG CHO
ỐNG HDPE & PPR
WATER METER BOX

ĐAI KÈO THẺY CHO ỐNG
UPVC & HDPE
UPVC & HDPE CLAMP SADDLE

PHỤ KIỆN HẠN ĐỘ BỊT HDPE
PE BUTT FUSION FITTING

PHỤ KIỆN HẠN ĐIỆN TRỞ
ELECTROFUSION FITTING SERIES

PHỤ KIỆN HẠN LÔNG
SOCKET JAWB SERIES

MÁY HÀN
BY UNIT PERSON WELDING MACHINE

ỐNG HDPE CẤP/THOÁT
HDPE WATER SUPPLY/SEWER

VÁN CÔNG GANG
PHỤ KIỆN GANG
CAST IRON MANHOLES

BÔNG HỒ NƯỚC
WATER METER

ỐNG GÂY XÓAN
HDPE LƯỚI ĐIỆN
HDPE EROSION CONTROL

PHỤ KIỆN NỐI ỐNG HDPE
BẢNG THÔNG SỐ PHÁP SÉT ĐOÀNG
DI PP COMPRESSION FITTING

VẬT NHỰA DÙNG CHO
ỐNG HDPE & PPR
PLASTIC BALL VALVE

NÁP MÀN TỀ CHÌM & LỚP ĐÓNG HỒ
PLASTIC WATER COVER &
WATER MATING BOX

ĐAI KÈO THẤY CHỖ ỐNG
UPVC & HDPE
UPVC & HDPE CLAMP STRAP

PHỤ KIỆN HẠN ĐỘ ĐỘ ĐỘ
PE BUT FUSION FITTING

PHỤ KIỆN HẠN ĐỘ TRỖ
ELECTROFUSION FITTING SERIES

PHỤ KIỆN HẠN LỖNG
SOCKET ANK SERIES

MÁY HÀN
ĐU UNIT FUSION WELDING MACHINE

ỐNG HDPE CẤP/THOÁT
HDPE WATER PIPE

VÁN CÔNG GẮNG
PHỤ KIỆN GẮNG

ĐỒNG HỒ NƯỚC
WATER METER

ỐNG GÁY XÒAN
HDPE LƯỚI ĐIỆN

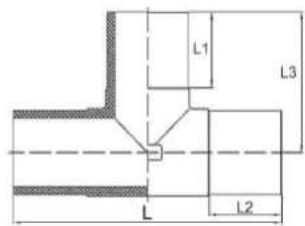

TÊ GIẢM BUTT FUSION REDUCING TEE

Code	Size (mm)	PN	PN	PN
THG11063	110-63-110	10	12.5	16
THG11075	110-75-110	10	12.5	16
THG11090	110-90-110	10	12.5	16
THG12590	125-90-125	10	12.5	16
THG125110	125-110-125	10	12.5	16
THG140110	140-110-140	10	12.5	16
THG140125	140-125-140	10	12.5	16
THG16063	160-63-160	10	12.5	16
THG16075	160-75-160	10	12.5	16
THG16090	160-90-160	10	12.5	16
THG160110	160-110-160	10	12.5	16
THG160125	160-125-160	10	12.5	16
THG180110	180-110-180	10	12.5	16
THG180125	180-125-180	10	12.5	16
THG180160	180-160-180	10	12.5	16
THG20063	200-63-200	10	12.5	16
THG20090	200-90-200	10	12.5	16
THG200110	200-110-200	10	12.5	16
THG200160	200-160-200	10	12.5	16
THG22575	225-75-225	10	12.5	16
THG22590	225-90-225	10	12.5	16

TÊ GIẢM BUTT FUSION REDUCING TEE

Code	Size (mm)	PN	PN	PN
THG225110	225-100-225	10	12.5	16
THG225160	225-160-225	10	12.5	16
THG225180	225-180-225	10	12.5	16
THG250110	250-110-250	10	12.5	16
THG250160	250-160-250	10	12.5	16
THG31590	315-90-315	10	12.5	16
THG315110	315-110-315	10	12.5	16
THG315200	315-160-315	10	12.5	16
THG315250	315-200-315	10	12.5	16
THG315250	315-250-315	10	12.5	16
THG355200	355-200-355	10	12.5	16
THG355250	355-250-315	10	12.5	16
THG400200	400-200-400	10	12.5	16
THG400250	400-250-400	10	12.5	16
THG400315	400-315-400	10	12.5	16
THG450250	450-250-450	10	12.5	16
THG450315	450-315-450	10	12.5	16
THG500315	500+315-500	10	12.5	16
THG500400	500-400-500	10	12.5	16
THG630450	630-450-630	10	12.5	16
THG630500	630-500-630	10	12.5	16

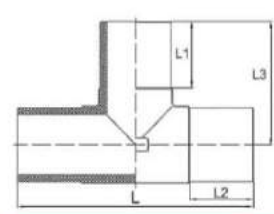

TÊ ĐỀU BUTT FUSION TEE

Code	Size (mm)	PN	PN	PN
TH63	63-63-63	10	12.5	16
TH75	75-75-75	10	12.5	16
TH90	90-90-90	10	12.5	16
TH110	110-110-110	10	12.5	16
TH125	125-125-125	10	12.5	16
TH140	140-140-140	10	12.5	16
TH160	160-160-160	10	12.5	16
TH180	180-180-180	10	12.5	16
TH200	200-200-200	10	12.5	16
TH225	225-225-225	10	12.5	16
TH250	250-250-250	10	12.5	16

TÊ ĐỀU BUTT FUSION TEE

Code	Size (mm)	PN	PN	PN
TH280	280-280-280	10	12.5	16
TH315	315-315-315	10	12.5	16
TH355	355-355-355	10	12.5	16
TH400	400-400-400	10	12.5	16
TH450	450-450-450	10	12.5	16
TH500	500-500-500	10	12.5	16
TH560	560-560-560	10	12.5	16
TH630	630-630-630	10	12.5	16
TH710	710-710-710	10	12.5	16
TH800	800-800-800	10	12.5	16

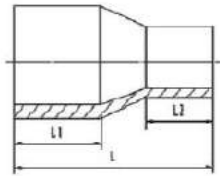

NỐI GIẢM BUTT FUSION REDUCER

Code	Size (mm)	PN	PN	PN
NG7550	75-50	10	12.5	16
NG7563	75-63	10	12.5	16
NG9050	90-50	10	12.5	16
NG9063	90-63	10	12.5	16
NG9075	90-75	10	12.5	16
NG11050	110-50	10	12.5	16
NG11063	110-63	10	12.5	16
NG11075	110-75	10	12.5	16
NG11090	110-90	10	12.5	16
NG12563	125-63	10	12.5	16
NG12575	125-75	10	12.5	16
NG12590	125-90	10	12.5	16
NG125110	125-110	10	12.5	16
NG14090	140-90	10	12.5	16
NG140110	140-110	10	12.5	16
NG140125	140-125	10	12.5	16
NG16063	160-63	10	12.5	16
NG16090	160-90	10	12.5	16
NG160110	160-110	10	12.5	16
NG160140	160-140	10	12.5	16
NG18090	180-90	10	12.5	16
NG160125	180-90	10	12.5	16
NG180110	180-110	10	12.5	16
NG180125	180-125	10	12.5	16
NG180140	180-140	10	12.5	16
NG180160	180-160	10	12.5	16
NG200110	200-110	10	12.5	16
NG200140	200-140	10	12.5	16
NG200160	200-160	10	12.5	16
NG200180	200-180	10	12.5	16
NG225160	225-160	10	12.5	16
NG225180	225-180	10	12.5	16
NG225200	225-200	10	12.5	16
NG250160	250-160	10	12.5	16
NG250180	250-180	10	12.5	16
NG250220	250-220	10	12.5	16
NG250225	250-225	10	12.5	16
NG280200	280-200	10	12.5	16
NG280225	280-225	10	12.5	16
NG280250	280-250	10	12.5	16
NG315220	315-220	10	12.5	16
NG315225	315-225	10	12.5	16
NG315250	315-250	10	12.5	16
NG225110	225-110	10	12.5	16

NỐI GIẢM BUTT FUSION REDUCER

Code	Size (mm)	PN	PN	PN
NG225110	225-110	10	12.5	16
NG250200	250-200	10	12.5	16
NG315160	315-160	10	12.5	16
NG315280	315-280	10	12.5	16
NG355250	355-250	10	12.5	16
NG355280	355-280	10	12.5	16
NG355315	355-315	10	12.5	16
NG400250	400-250	10	12.5	16
NG400280	400-280	10	12.5	16
NG400315	400-315	10	12.5	16
NG400355	400-355	10	12.5	16
NG450400	450-400	10	12.5	16
NG500400	500-400	10	12.5	16
NG500450	500-450	10	12.5	16
NG560400	560-400	10	12.5	16
NG560450	560-450	10	12.5	16
NG560500	560-500	10	12.5	16
NG630400	630-400	10	12.5	16
NG630450	630-450	10	12.5	16
NG630500	630-500	10	12.5	16
NG630560	630-560	10	12.5	16
NG710630	710-630	10	12.5	16
NG800630	800-630	10	12.5	16
NG800710	800-710	10	12.5	16

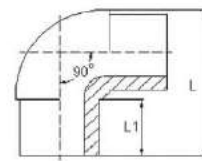

CÚT 90° BUTT FUSION ELBOW 90°

Code	Size (mm)	PN	PN	PN
CH110	110x90°	10	12.5	16
CH125	125x90°	10	12.5	16
CH140	140x90°	10	12.5	16
CH160	160x90°	10	12.5	16
CH180	180x90°	10	12.5	16
CH200	200x90°	10	12.5	16
CH225	225x90°	10	12.5	16
CH250	250x90°	10	12.5	16
CH280	280x90°	10	12.5	16
CH315	315x90°	10	12.5	16
CH355	355x90°	10	12.5	16
CH400	400x90°	10	12.5	16
CH480	480x90°	10	12.5	16
CH500	500x90°	10	12.5	16
CH560	560x90°	10	12.5	16
CH630	630x90°	10	12.5	16
CH710	710x90°	10	12.5	16
CH800	800x90°	10	12.5	16

PHỤ KIỆN NỐI ỐNG HDPE
BẢNG PHƯƠNG PHÁP SÉT GIÓNG
DI PP COMPRESSION FITTING

VAN NHỰA DÙNG CHO
ỐNG HDPE & PPR
PLASTIC BALL VALVE

NẮP HẸM CHÌM & LẮP ĐỒNG HỒ
PLASTIC WATER VALVE COVER &
WATER METER BOX

ĐAI KHIẾM THỂ CHỊU ỒNG
UPVC & HDPE
UPVC & HDPE CLAMP BRIDLE

PHỤ KIỆN HẸM ĐỐI ĐẦU HDPE
PE BUTT FUSION FITTING

PHỤ KIỆN HẸM ĐIỆN TRỞ
ELECTROFUSION FITTING SERIES

PHỤ KIỆN HẸM LỒNG
SOCKET JAW SERIES

MÁY HẸM
PE BUTT FUSION WELDING MACHINE

ỐNG HDPE CÁP/THOẠT

VAN CÔNG BẰNG
PHỤ KIỆN GÁNG

ĐỒNG HỒ NƯỚC

ỐNG GÁNH XOÀN
HDPE LƯỚI ĐIỆN

PHỤ KIỆN HDPE HÀ ĐIỆN TRỞ

Electrofusion Fitting Series



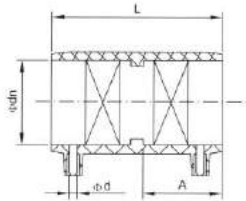

NỐI THẲNG HÀN ĐIỆN TRỞ ELECTROFUSION COUPLER

(Specification) phi dn	A	phi d	(Item Number)
20	40	4.7	XDI-20
25	43	4.7	XDI-25
32	44	4.7	XDI-32
40	45	4.7	XDI-40
50	50	4.7	XDI-50
63	50	4.7	XDI-63
75	65	4.7	XDI-75
90	63	4.7	XDI-90
110	70	4.7	XDI-110
125	80	4.7	XDI-125
140	80	4.7	XDI-140
160	85	4.7	XDI-160
180	100	4.7	XDI-180
200	100	4.7	XDI-200
225	105	4.7	XDI-225
250	105	4.7	XDI-250
315	110	4.7	XDI-315
355	130	4.7	XDI-355
400	150	4.7	XDI-400
500	180	4.7	XDI-500
560	185	4.7	XDI-560
630	205	4.7	XDI-630

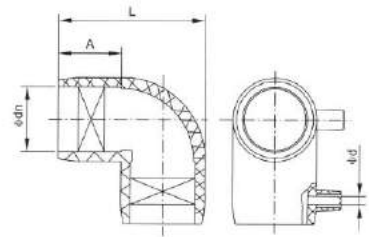

CÚT HÀN ĐIỆN TRỞ 90° ELECTROFUSION ELBOW 90°

(Specification) phi dn X 90°	A	phi d	(Item Number)
25X90°	42	4.7	XDL-25
32X90°	45	4.7	XDL-32
40X90°	50	4.7	XDL-40
50X90°	50	4.7	XDL-50
63X90°	55	4.7	XDL-63
75X90°	60	4.7	XDL-75
90X90°	65	4.7	XDL-90
110X90°	70	4.7	XDL-110
125X90°	80	4.7	XDL-125
160X90°	80	4.7	XDL-160
180X90°	85	4.7	XDL-180
200X90°	102	4.7	XDL-200
250X90°	113	4.7	XDL-250
315X90°	127	4.7	XDL-315
400X90°	140	4.7	XDL-400

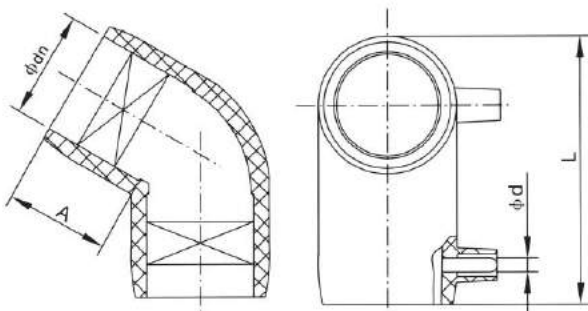

CÚT HÀN ĐIỆN TRỞ 45° ELECTROFUSION ELBOW 45°

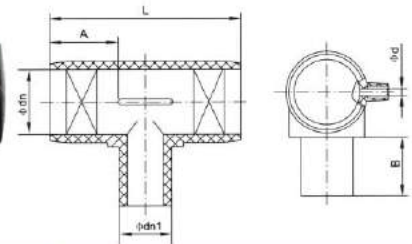

TÊ ĐỀU HÀN ĐIỆN TRỞ ELECTROFUSION EQUAL TEE

(Specification) phi dn X phi dn1 x phi dn	A	B	phi d	(Item Number)
20X20X20	40	40	4.7	XDT-20
25X25X25	45	50	4.7	XDT-25
32X32X32	45	55	4.7	XDT-35
40X40X40	45	60	4.7	XDT-40
50X50X50	55	60	4.7	XDT-50
63X63X63	55	60	4.7	XDT-63
75X75X75	68	70	4.7	XDT-75
90X90X90	68	75	4.7	XDT-90
110X110X110	75	79	4.7	XDT-110
125X125X125	80	85	4.7	XDT-125
160X160X160	90	95	4.7	XDT-160
180X180X180	98	100	4.7	XDT-180
200X200X200	98	105	4.7	XDT-200
250X250X250	98	115	4.7	XDT-250
315X315X315	125	115	4.7	XDT-315
400X400X400	125	115	4.7	XDT-400

PHỤ KIỆN NỐI ỐNG HDPE
BẢNG THÔNG SỐ SẢN PHẨM
DI: PP COMPRESSION FITTING

VAN NHỰA DÙNG CHO
ỐNG HDPE & PPR
PLASTIC BALL VALVE

MÁP NHỰA DÙNG CHO
ỐNG HDPE VÀ/OR
WATER METER BOX

ĐAI KÈM THỬY CHỌI ỐNG
UPVC & HDPE
UPVC & HDPE CLAMP BRADLE

PHỤ KIỆN HÀN ĐỐI ĐẦU HDPE
PE-BIT TUBING FITTING

PHỤ KIỆN HÀN ĐIỆN TRỞ
ELECTROFUSION FITTING SERIES

PHỤ KIỆN HÀN LỒNG
SOCKET JAWB SERIES

MÁY HÀN
EU UNIT FUSION WELDING MACHINE

ỐNG HDPE CÁP/THOÁT
HDPE PIPE

VAN CÔNG GĂNG
PHỤ KIỆN GĂNG
PLASTIC BALL VALVE

ĐỒNG HỒ NƯỚC
WATER METER

ỐNG GÂY XÒAN
HDPE LƯỚI ĐIỆN
HDPE PIPE

PHỤ KIỆN NỐI ỐNG HDPE
BĂNG PHƯƠNG PHÁP SÉT ĐOÀNG
DI PP COMPRESSION FITTING

VÁN NHỰA DÙNG CHO
ỐNG HDPE & PPR
PLASTIC BALL VALVE

NÁP WATY CHÌM LẤP ĐÓNG HỒ
PLASTIC WATER COVER &
WATER MATTER BOX

ĐAI KẾT THỐI CHỖ ỐNG
UPVC & HDPE
UPVC & HDPE SADDLE

PHỤ KIỆN HÀN ĐỐI ĐẦU HDPE
PE BUTT FUSION FITTING

PHỤ KIỆN HÀN ĐIỆN TRỞ
ELECTROFUSION FITTING SERIES

PHỤ KIỆN HÀN LỒNG
SOCKET ANNE SERIES

MÁY HÀN
ĐÚ UNIT FUSION WELDING MACHINE

ỐNG HDPE CÁP/THOÁT
HDPE PIPE CLAMP

VÁN CÔNG GANG,
PHỤ KIỆN GANG
CAST IRON VALVE

ĐỒNG HỒ NƯỚC
WATER METER

ỐNG GÂY XANH
HDPE LƯỚI ĐIỆN
HDPE ELECTRIC FIBER OPTIC

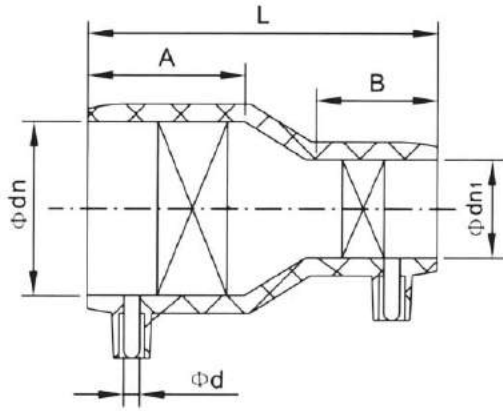

NỐI GIẢM HÀN ĐIỆN TRỞ / ELECTROFUSION REDUCER

(Specification) φdnX90°	A	φd	(Item Number)
50X45°	50	4.7	XDVL-50
63X45°	63	4.7	XDVL-63
90X45°	83	4.7	XDVL-90
110X45°	85	4.7	XDVL-110
160X45°	85	4.7	XDVL-160
200X45°	100	4.7	XDVL-200
250X45°	110	4.7	XDVL-250
315X45°	125	4.7	XDVL-315
400X45°	140	4.7	XDVL-400

NỐI GIẢM HÀN ĐIỆN TRỞ / ELECTROFUSION REDUCER

(Specification) φ dn X φ dn1	A	B	φd	(Item Number)
25X20	42	35	4.7	XDS-25/20
32X20	42	40	4.7	XDS-32/20
32X25	42	40	4.7	XDS-32/25
40X25	50	40	4.7	XDS-40/25
40X32	50	40	4.7	XDS-40/32
50X25	55	40	4.7	XDS-50/25
50X32	55	40	4.7	XDS-50/32
50X40	50	50	4.7	XDS-50/40
63X25	60	40	4.7	XDS-63/25
63X32	60	40	4.7	XDS-63/32
63X40	55	40	4.7	XDS-63/40
63X50	55	50	4.7	XDS-63/50
75X50	65	50	4.7	XDS-75/50
75X63	65	50	4.7	XDS-75/63
90X50	65	55	4.7	XDS-90/50
90X63	65	55	4.7	XDS-90/63
90X75	65	60	4.7	XDS-90/75
110X63	75	55	4.7	XDS-110/63
110X75	75	60	4.7	XDS-110/75
110X90	75	65	4.7	XDS-110/90
125X63	80	60	4.7	XDS-125/63
125X90	80	70	4.7	XDS-125/90
125X110	85	69	4.7	XDS-125/110
160X90	94	74	4.7	XDS-160/90
160X110	95	75	4.7	XDS-160/110
160X125	95	75	4.7	XDS-160/125
200X110	95	80	4.7	XDS-200/110
200X160	95	85	4.7	XDS-200/160
250X110	100	80	4.7	XDS-250/110
250X160	110	90	4.7	XDS-250/160
250X200	110	100	4.7	XDS-250/200
315X200	100	100	4.7	XDS-315/200
315X250	100	100	4.7	XDS-315/250
400X250	110	105	4.7	XDS-400/250
400X315	110	105	4.7	XDS-400/315

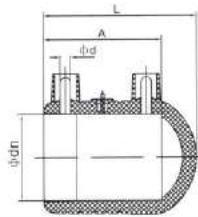

ĐẦU BỊT HÀN ĐIỆN TRỞ / ELECTROFUSION END CAP

(Specification) φdnX90°	A	φd	(Item Number)
32	45	4.7	XDM-32
40	55	4.7	XDM-40
50	55	4.7	XDM-50
63	55	4.7	XDM-63
90	55	4.7	XDM-90
110	70	4.7	XDM-110

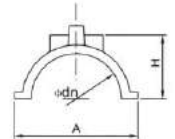
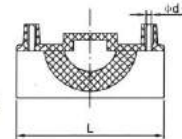

ĐAI SỬA CHỮA HÀN ĐIỆN TRỞ / ELECTROFUSION REPAIR SADDLE

(Specification) φdn	A	φd	(Item Number)
90	154	4.7	XDU-90
110	160	4.7	XDU-110
160	230	4.7	XDU-160
200	235	4.7	XDU-200
250	300	4.7	XDU-250
315	300	4.7	XDU-315

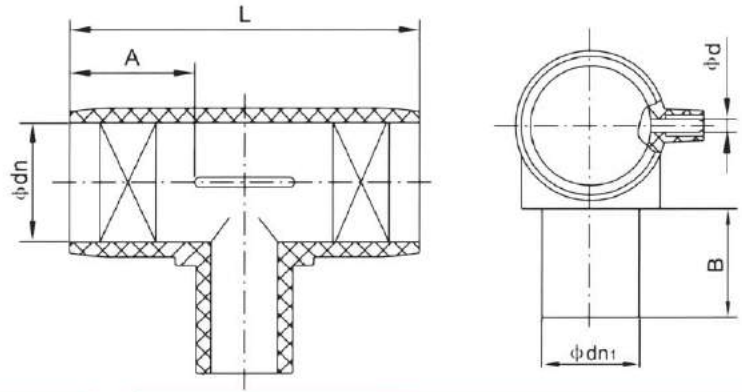

TÊ GIẢM HÀN ĐIỆN TRỞ / ELECTROFUSION REDUCUNG TEE

(Specification) phi dn X phi dn1 x phi dn	A	B	phi d	(Item Number)
25X20X25	45	50	4.7	XDST-25/20
32X20X32	45	50	4.7	XDST-32/20
32X25X32	45	50	4.7	XDST-32/25
40X25X40	45	55	4.7	XDST-40/25
40X32X40	45	55	4.7	XDST-40/32
50X25X50	50	50	4.7	XDST-50/25
50X32X50	50	55	4.7	XDST-50/32
50X40X50	50	55	4.7	XDST-50/40
63X25X63	50	55	4.7	XDST-63/25
63X32X63	50	55	4.7	XDST-63/32
63X40X63	50	55	4.7	XDST-63/40
63X50X63	55	55	4.7	XDST-63/50
75X32X75	70	70	4.7	XDST-75/32
75X40X75	70	70	4.7	XDST-75/40
75X50X75	70	70	4.7	XDST-75/50
75X63X75	70	70	4.7	XDST-75/63
90X32X90	70	80	4.7	XDST-90/32
90X40X90	70	80	4.7	XDST-90/40
90X50X90	70	80	4.7	XDST-90/50
90X63X90	70	80	4.7	XDST-90/63
90X75X90	70	75	4.7	XDST-90/75
110X32X110	75	80	4.7	XDST-110/32
110X40X110	75	80	4.7	XDST-110/40
110X50X110	75	80	4.7	XDST-110/50

TÊ GIẢM HÀN ĐIỆN TRỞ / ELECTROFUSION REDUCUNG TEE

(Specification) phi dn X phi dn1 x phi dn	A	B	phi d	(Item Number)
110X63X110	75	80	4.7	XDST-110/63
110X75X110	75	80	4.7	XDST-110/75
110X90X110	75	80	4.7	XDST-110/90
125X90X125	80	85	4.7	XDST-125/90
125X110X125	80	85	4.7	XDST-125/110
160X63X160	90	90	4.7	XDST-160/63
160X75X160	90	90	4.7	XDST-160/75
160X90X160	90	90	4.7	XDST-160/90
160X110X160	90	90	4.7	XDST-160/110
160X125X160	90	80	4.7	XDST-160/125
200X90X200	98	75	4.7	XDST-200/90
200X110X200	98	75	4.7	XDST-200/110
200X160X200	98	90	4.7	XDST-200/160
250X110X250	98	95	4.7	XDST-250/110
250X160X250	98	110	4.7	XDST-250/160
250X200X250	98	110	4.7	XDST-250/200
315X110X315	125	100	4.7	XDST-315/110
315X160X315	125	100	4.7	XDST-315/160
315X200X315	125	100	4.7	XDST-315/200
315X250X315	125	120	4.7	XDST-315/250
400X110X400	125	115	4.7	XDST-400/110
400X160X400	125	115	4.7	XDST-400/160
400X200X400	125	115	4.7	XDST-400/200
400X250X400	125	115	4.7	XDST-400/250
400X315X400	125	115	4.7	XDST-400/315

PHỤ KIỆN NỐI ỐNG HDPE
BẢNG PHƯƠNG PHÁP SÉT GIÓNG
DI PP COMPRESSION FITTING

VAN NHỰA DÙNG CHO
ỐNG HDPE & PPR
PLASTIC BALL VALVE

MÁP NHỰA CHÌM & HỘP ĐÓNG HỖ
ỐNG HDPE & PPR
WATER TIGHT BOX

ĐAI KÈO THỖY CHO ỐNG
UPVC & HDPE
UPVC & HDPE CLAMP SADDLE

PHỤ KIỆN HÀN ĐỐI ĐẦU HDPE
PE BUTT FUSION FITTING

PHỤ KIỆN HÀN ĐIỆN TRỞ
ELECTROFUSION FITTING SERIES

PHỤ KIỆN HÀN LỒNG
SOCKET JAWN SERIES

MÁY HÀN
DI BUTT FUSION WELDING MACHINE

ỐNG HDPE CẤP/THOÁT

VAN CÔNG BĂNG,
PHỤ KIỆN GĂNG

BÔNG HỒ NƯỚC

ỐNG GÂY XÒAN
HDPE LUỒN ĐIỆN

PHỤ KIỆN NỐI ỐNG HDPE
BẢNG PHƯƠNG PHÁP SÉT ĐOÁNG
BY PP COMPRESSION FITTING

VÁN NHỰA DÙNG CHO
ỐNG HDPE & PPR
PLASTIC GALL VALVE

NÁP HẠT THỦY CHÌM & LỚP ĐÓNG HỖ
PLASTIC WATER VALVE COVER &
WATER MATTER BOX

ĐAI KÈO THỦY CHÌM ỐNG
UPVC & HDPE
UPVC & HDPE CLAMP SADDLE

PHỤ KIỆN HÀN ĐỐI ĐẦU HDPE
PE BUTT JOINT FITTING

PHỤ KIỆN HÀN ĐIỆN TRÒ
ELECTROFUSION FITTING SERIES

PHỤ KIỆN HÀN LỒNG
SOCKET JAW SERIES

MÁY HÀN
ĐỐI ĐẦU FERROM WELDING MACHINE

ỐNG HDPE CẤP/THOÁT

VÁN CÔNG GÁNG,
PHỤ KIỆN GÁNG

ĐỒNG HỒ NƯỚC

ỐNG GÁY XỐN
HDPE LƯỚI ĐIỆN

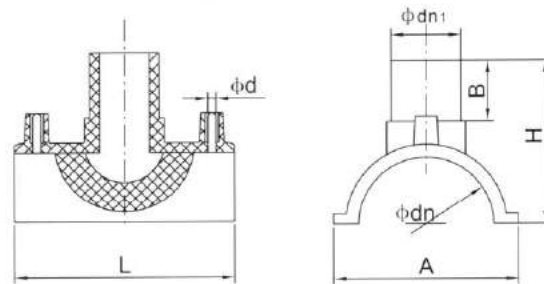
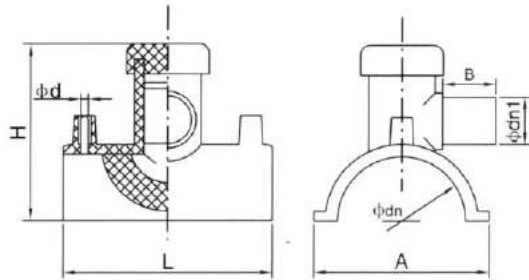

ĐAI KÈO THỦY TỰ KHOAN LỖ / ELECTROFUSION TAPPING SADDLE

(Specification) phi dn1 X phi dn1	A	B	B	phi d	(Item Number)
63X25	104	50	129	4.7	XDF-63/25
63X32	104	50	129	4.7	XDF-63/32
90X25	130	75	185	4.7	XDF-90/25
90X50	130	75	185	4.7	XDF-90/50
90X63	130	75	185	4.7	XDF-90/63
110X20	155	55	145	4.7	XDF-110/20
110X25	155	55	145	4.7	XDF-110/25
110X32	155	55	145	4.7	XDF-110/32
110X50	160	75	175	4.7	XDF-110/50
110X63	160	75	175	4.7	XDF-110/63
160X63	240	85	225	4.7	XDF-160/63
160X90	240	160	225	4.7	XDF-160/90
200X63	255	85	215	4.7	XDF-200/63
200X90	255	160	215	4.7	XDF-200/90
250X63	265	85	215	4.7	XDF-250/63
250X90	265	160	215	4.7	XDF-250/90
315X63	310	85	240	4.7	XDF-315/63
315X90	310	160	240	4.7	XDF-315/90

ĐAI KÈO THỦY HÀN ĐIỆN TRÒ / ELECTROFUSION BRANCH SADDLE

(Specification) phi dn1 X phi dn1	A	B	B	phi d	(Item Number)
63X32	155	80	145	4.7	XDFI-63/32
90X63	155	80	145	4.7	XDFI-90/63
110X32	160	80	145	4.7	XDFI-110/32
110X63	160	80	145	4.7	XDFI-110/63
160X63	230	100	185	4.7	XDFI-160/63
160X90	230	100	185	4.7	XDFI-160/90
200X63	235	110	185	4.7	XDFI-200/63
200X90	235	115	195	4.7	XDFI-200/90
250X63	300	115	195	4.7	XDFI-250/63
250X90	300	115	195	4.7	XDFI-250/90
315X63	300	115	195	4.7	XDFI-315/63
315X90	300	120	200	4.7	XDFI-315/90



PHỤ KIỆN HÀ LỒNG SOCKET JOINT SERIES

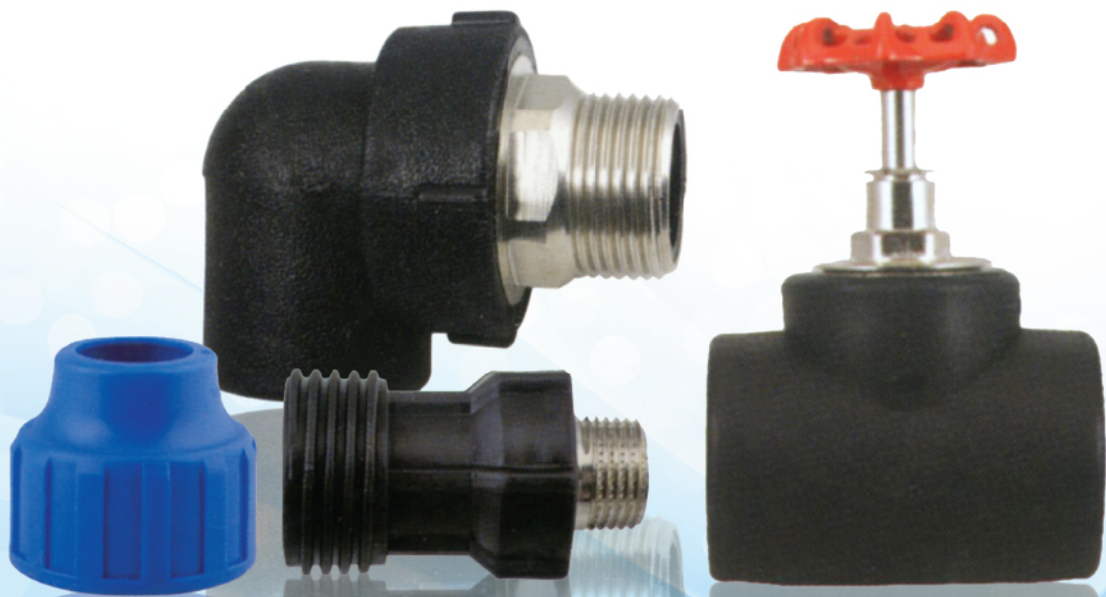



NỎI GIẢM REDUCING COUPLING

(Specification) φdn	(Item Number)	(Specification) φdn	(Item Number)
25X20	XDCS-25/20	63X20	XDCS-63/20
32X20	XDCS-32/20	63X25	XDCS-63/25
32X25	XDCS-32/25	63X32	XDCS-63/32
40X20	XDCS-40/20	63X40	XDCS-63/40
40X25	XDCS-40/25	63X50	XDCS-63/50
40X32	XDCS-40/32	75X32	XDCS-75/32
50X20	XDCS-50/20	75X40	XDCS-75/40
50X25	XDCS-50/25	75X50	XDCS-75/50
50X32	XDCS-50/32	75X63	XDCS-75/63
50X40	XDCS-50/40		



TÊ GIẢM REDUCING TEE

(Specification) φdn	(Item Number)	(Specification) φdn	(Item Number)
25X20	XDCST-25/20	50X40	XDCST-50/40
32X20	XDCST-32/20	63X20	XDCST-63/20
32X25	XDCST-32/25	63X25	XDCST-63/25
40X20	XDCST-40/20	63X32	XDCST-63/32
40X25	XDCST-40/25	63X40	XDCST-63/40
40X32	XDCST-40/32	63X50	XDCST-63/50
50X20	XDCST-50/20	75X40	XDCST-75/40
50X25	XDCST-50/25	75X50	XDCST-75/50
50X32	XDCST-50/32	75X63	XDCST-75/63

NỎI THẲNG EQUAL COUPLING



(Specification)	(Item Number)
20	XDCI-20
25	XDCI-25
32	XDCI-32
40	XDCI-40
50	XDCI-50
63	XDCI-63
75	XDCI-75

TÊ ĐỀU EQUAL TEE



(Specification)	(Item Number)
20	XDCT-20
25	XDCT-25
32	XDCT-32
40	XDCT-40
50	XDCT-50
63	XDCT-63
75	XDCT-75

CÚT 45° 45° EQUAL ELBOW



(Specification)	(Item Number)
20	XDCVL-20
25	XDCVL-25
32	XDCVL-32
40	XDCVL-40
50	XDCVL-50
63	XDCVL-63
75	XDCVL-75

CÚT 90° 90° EQUAL ELBOW



(Specification)	(Item Number)
20	XDCL-20
25	XDCL-25
32	XDCL-32
40	XDCL-40
50	XDCL-50
63	XDCL-63
75	XDCL-75

MẶT BÍCH SOCKET WASHER



(Specification)	(Item Number)
40	XDCD-40
50	XDCD-50
63	XDCD-63
75	XDCD-75

ĐẦU BỊT END CAP



(Specification)	(Item Number)
20	XDCM-20
25	XDCM-25
32	XDCM-32
40	XDCM-40
50	XDCM-50
63	XDCM-63
75	XDCM-75

PHỤ KIỆN NỐI ỐNG HDPE
BẢNG THÔNG PHÁP SẴT ĐOÀNG
DI PP COMPRESSION FITTING

VAN NHỰA DÙNG CHO
ỐNG HDPE & PPR
PLASTIC BALL VALVE

NÁP KHUỖI CHÌM & LỚP BẢO HỘ
ỐNG HDPE
PLASTIC WATER VALVE COVER &
WATER PROTECT BOX

ĐAI KHUỖI THẤY CHỖ ỐNG
UPVC & HDPE
UPVC & HDPE CLAMP SADDLE

PHỤ KIỆN HẠN ĐỐI ĐẦU HDPE
PE BUTT FUSION FITTING

PHỤ KIỆN HẠN ĐIỆN TRỞ
ELECTRODRIFT FITTING SERIES

PHỤ KIỆN HẠN LỒNG
SOCKET JOIN SERIES

MÁY HÀN
ĐÚI UNIT FERROM WELDING MACHINE

ỐNG HDPE CÁP/THOÁT
HDPE PIPE CAP/VENT

VAN CÔNG GẮNG,
PHỤ KIỆN GẮNG
HAND OPERATED VALVE,
FITTING

ĐỒNG HỒ NƯỚC
WATER METER

ỐNG GÂY XÒAN
HDPE LƯỚI ĐIỆN
HDPE BONDING WIRE

NỐI REN TRONG FEMALE ADAPTER



(Specification)	(Item Number)
20X1/2" F	XDCFI- 20X1/2"
25X1/2" F	XDCFI- 25X1/2"
25X3/4" F	XDCFI- 25X3/4"
32X1" F	XDCFI- 32X1"
32X1/2" F	XDCFI- 32X1/2"
32X3/4" F	XDCFI- 32X3/4"
40X1 ^{1/4} " F	XDCFI- 40X1 ^{1/4} "
40X1 ^{1/2} " F	XDCFI- 40X1 ^{1/2} "
63X2" F	XDCFI- 63X2"

NỐI REN NGOÀI MALE ADAPTER



(Specification)	(Item Number)
20X1/2" M	XDCMI- 20X1/2"
25X1/2" M	XDCMI- 25X1/2"
25X3/4" M	XDCMI- 25X3/4"
32X1" M	XDCMI- 32X1"
32X1/2" M	XDCMI- 32X1/2"
32X3/4" M	XDCMI- 32X3/4"
40X1 ^{1/4} " M	XDCMI- 40X1 ^{1/4} "
40X1 ^{1/2} " M	XDCMI- 40X1 ^{1/2} "
63X2" M	XDCMI- 63X2"

CÚT REN TRONG FEMALE ELBOW



(Specification)	(Item Number)
20X1/2" F	XDCFL- 20X1/2"
25X1/2" F	XDCFL- 25X1/2"
25X3/4" F	XDCFL- 25X3/4"
32X1" F	XDCFL- 32X1"
32X1/2" F	XDCFL- 32X1/2"
32X3/4" F	XDCFL- 32X3/4"

CÚT REN NGOÀI MALE ELBOW



(Specification)	(Item Number)
20X1/2" M	XDCML- 20X1/2"
25X1/2" M	XDCML- 25X1/2"
25X3/4" M	XDCML- 25X3/4"
32X1" M	XDCML- 32X1"
32X1/2" M	XDCML- 32X1/2"
32X3/4" M	XDCML- 32X3/4"

TÊ REN TRONG FEMALE TEE



(Specification)	(Item Number)
20X1/2" F	XDCFT- 20X1/2"
25X1/2" F	XDCFT- 25X1/2"
25X3/4" F	XDCFT- 25X3/4"
32X1" F	XDCFT- 32X1"
32X1/2" F	XDCFT- 32X1/2"
32X3/4" F	XDCFT- 32X3/4"

TÊ REN NGOÀI MALE TEE



(Specification)	(Item Number)
20X1/2" M	XDCMT- 20X1/2"
25X1/2" M	XDCMT- 25X1/2"
25X3/4" M	XDCMT- 25X3/4"
32X1" M	XDCMT- 32X1"
32X1/2" M	XDCMT- 32X1/2"
32X3/4" M	XDCMT- 32X3/4"

RẮC-CO REN TRONG FEMALE UNION



(Specification)	(Item Number)
20X1/2" F	XDCFH- 20X1/2"
25X3/4" F	XDCFH- 25X3/4"
32X1" F	XDCFH- 32X1"
40X1 ^{1/4} " F	XDCFH- 40X1 ^{1/4} "
40X1 ^{1/2} " F	XDCFH- 40X1 ^{1/2} "
63X2" F	XDCFH- 63X2"

RẮC-CO REN NGOÀI MALE UNION



(Specification)	(Item Number)
20X1/2" M	XDCMH- 20X1/2"
25X3/4" M	XDCMH- 25X3/4"
32X1" M	XDCMH- 32X1"
40X1 ^{1/4} " M	XDCFH- 40X1 ^{1/4} "
40X1 ^{1/2} " M	XDCFH- 40X1 ^{1/2} "
63X2" M	XDCFH- 63X2"

PHỤ KIỆN NỐI ỐNG HỢP
BẢNG THÔNG PHÁP SẴN GIỎNG
DI PP COMPRESSION FITTING

VAN NHỰA DÙNG CHO
ỐNG NHỰA VẢI CỎ & PPR
PLASTIC BALL VALVE

NÁP VAN TỶ CHỈM & HỘP ĐỒNG HỒ
PLASTIC WATER VALVE COVER &
WATER METER BOX

BÀI KHOI THỬ CHỌI ỐNG
UPVC & HDPE
UPVC & HDPE CLAMP SAMPLE

PHỤ KIỆN HẠN ĐỐI ĐẦU HỢP
PE BUILT IN FUSION FITTING

PHỤ KIỆN HẠN ĐIỆN TRỞ
ELECTROFUSION FITTING SERIES

PHỤ KIỆN HẠN LÔNG
SOCKET JAWING SERIES

MÁY HÀN
EU BUILT FUSION WELDING MACHINE

ỐNG HỢP CẤP/THOÁT

VAN CÔNG BĂNG
PHỤ KIỆN CÔNG

ĐỒNG HỒ NƯỚC

ỐNG GÂY XÒAN
HỢP LƯỚI ĐIỆN

PHỤ KIỆN NỐI ỐNG HDPE
BẢNG THÔNG SỐ SẢN PHẨM
DI PP COMPRESSION FITTING

VAN NHỰA DÙNG CHO
ỐNG HDPE & PPR
PLASTIC BALL VALVE

NÁP HẠT CHÌM & LỚP BẢO VỆ
PLASTIC WATER VALVE COVER &
WATER MATEB BOX

BÀI KÈM THUYẾT MINH
UPVC & HDPE
UPVC & HDPE CLAMP BRIDLE

PHỤ KIỆN HẠN ĐỘ GIỮ HDPE
PE BOLT FUSION FITTING

PHỤ KIỆN HẠN ĐIỆN TRỞ
ELECTROFUSION FITTING SERIES

PHỤ KIỆN HẠN LƯỜNG
SOCKET HMM SERIES

MÁY HÁN
HD UNIT FUSION WELDING MACHINE

ỐNG HDPE CẤP/THOÁT

VAN CÔNG GANG
PHỤ KIỆN GANG

BÔNG HỒ NƯỚC

ỐNG GÂY XÒAN
HDPE LUỒN ĐIỆN

NỐI REN TRONG BUTT FUSION FEMALE ADAPTER



(Specification)	(Item Number)
20X1/2" F	XDRFL- 20X1/2"
25X3/4" F	XDRFL- 25X3/4"
32X1" F	XDRFL- 32X1"
40X1 1/4" F	XDRFL- 40X1 1/4"
40X1 1/2" F	XDRFL- 40X1 1/2"
63X2" F	XDRFL- 63X2"
90X3" F	XDRFL- 90X3"

NỐI REN NGOÀI BUTT FUSION MALE ADAPTER



(Specification)	(Item Number)
20X1/2" M	XDRML- 20X1/2"
25X3/4" M	XDRML- 25X3/4"
32X1" M	XDRML- 32X1"
40X1 1/4" M	XDRML- 40X1 1/4"
40X1 1/2" M	XDRML- 40X1 1/2"
63X2" M	XDRML- 63X2"
90X3" M	XDRML- 90X3"

NỐI REN ĐỒNG REN NGOÀI COMPRESSION COUPLING



(Specification)	(Item Number)
20X1/2" M	XDKSMI- 20X1/2"
25X3/4" M	XDKSMI- 25X3/4"
32X1" M	XDKSMI- 32X1"



CÚT REN ĐỒNG REN NGOÀI COMPRESSION ELLBOW



(Specification)	(Item Number)
20X1/2" M	XDKSML- 20X1/2"
25X3/4" M	XDKSML- 25X3/4"
32X1" M	XDKSML- 32X1"



VAN STOP VALVE



(Specification)	(Item Number)
20	XDCJ- 20
25	XDCJ- 25
32	XDCJ- 32
40	XDCJ- 40
50	XDCJ- 50
63	XDCJ- 63
75	XDCJ- 75

MÁY HÀN

EU BUTT FUSION WELDING MACHINE



1 SHD450-630 Planing Tool

2 SHD450-630 Heating Plate

3 SHD450-630 Basic Frame

4 SHD450-630 Heating Plate Connection

5 SHD450-630 Support

6 SHD450-630 Heating Plate Connection

7 SHD450-630 Hydraulic Unit



MÁY HÀN THỦY LỰC
HYDRAULIC BUTT FUSION WELDING MACHINE

Tính năng/Brief: Dùng để hàn ống và phụ kiện nhựa PE, PP/Suitable for welding of plastic pipes and fittings made from PE, PP
Chất liệu/Material: Nhôm/Aluminum

Ép bằng thủy lực/Hydraulic Unit provides welding machine with compressing power

Bộ điều khiển nhiệt độ và hẹn giờ, dễ dàng trong kiểm soát quá trình hàn/Temperature Controller and Timer, easy to know the exact time and temperature

THÔNG SỐ KỸ THUẬT/SPECIFICATION								
Loại/Model	AP160-4H	AP200-4H	AP250-4H	AP315-4H	AP400-4H	AP450-4H	AP500-4H	AP630-4H
Biên độ hàn/Welding Range (mm)	63 75 90 110 125 140 160	63 75 90 110 125 140 160 200	63 110 125 140 160 200 250	90 110 125 140 160 200 250 280 315	200 250 280 315 355 400	280 315 355 400 450	280 315 355 400 450 500	315 355 400 450 500 630
Nhiệt độ hàn lớn nhất/ Heating Plate Max. Temp.	270°C							
Nhiệt độ bề mặt/Temp. Deviation un Surface	±5°C							
Điện áp/Working Voltage	220V 50HZ	220V 50HZ	220V 50HZ	220V 50HZ	380/220V 50HZ	380/220V 50HZ	380/220V 50HZ	380/220V 50HZ
Công suất tấm gia nhiệt/ Heating Placte Power	1.5KW	1.8KW	2.1KW	3.5KW	4 KW	5.38KW	6.5KW	9.5KW
Công suất máy cắt bề mặt/Plan tool power	1.1KW	1.1KW	1.1KW	1.1KW	1.5KW	1.5KW	1.5KW	1.5KW
Công suất thủy lực/ Hydraulic unit power	0.75KW	0.75KW	0.75KW	0.75KW	1.5KW	1.5KW	1.5KW	1.5KW
Tổng công suất/ Total power	3.35KW	3.65KW	3.95KW	5.35KW	7KW	8.38KW	9.5KW	12.5KW
Áp lực ép/Pressure Adjustable Ranges	0-6.3MPa	0-6.3MPa	0-6.3MPa	0-6.3MPa	0-6.3MPa	0-6.3MPa	0-6.3MPa	0-6.3MPa
Trọng lượng/Weight	120KG	135KG	180KG	230KG	420KG	450KG	560KG	650KG
Khối lượng/Volume	0.50M'	0.53M'	0.80M'	1M'	1.80M'	2.20M'	2.5M'	3.2M'
Màu sắc/ Color	Xanh nước biển, Xanh lá cây, đỏ/Blue, green, red							



MÁY HÀN CƠ VITME
BUTT FUSION WELDING MACHINE

Tính năng/ Brief: Dùng để hàn ống và phụ kiện nhựa PE, PP/Suitable for welding of plastic pipes and fittings made from PE, PP
Chất liệu/ Material: Nhôm/ Aluminum

THÔNG SỐ KỸ THUẬT/ SPECIFICATION

Loại/Model	AP160M-C4	AP200M-C4
Biên độ hàn/ Welding Range (mm)	63 75 90 110 125 140 160	63 75 90 110 125 140 160 200
Nhiệt độ hàn lớn nhất/ Heating Plate Max. Temp.	270°C	
Nhiệt độ bề mặt/ Temp. Deviation un Surface	≤±5°C	
Điện áp/Working Voltage	220V 50HZ	
Công suất tấm gia nhiệt/ Heating Placte Power	1.0KW	1.6KW
Công suất máy cắt bề mặt/ Plan tool power	0.71KW	
Tổng công suất/ Total power	1.71KW	2.31KW
Áp lực ép/ Pressure Adjustable Ranges	0-6.3MPa	
Trọng lượng/ Weight	40KG	45KG
Khối lượng/ Volume	0.18M'	0.18M'
Màu sắc/ Color	Xanh nước biển, Xanh lá cây, đỏ/Blue, green, red	



MÁY HÀN CƠ ÉP TRỰC
BUTT FUSION WELDING MACHINE

Tính năng/ Brief: Dùng để hàn ống và phụ kiện nhựa PE, PP/Suitable for welding of plastic pipes and fittings made from PE, PP
Chất liệu/ Material: Nhôm/ Aluminum

THÔNG SỐ KỸ THUẬT/ SPECIFICATION

Loại/Model	AP160M-A2	AP200M-A2
Biên độ hàn/ Welding Range (mm)	63 75 90 110 125 140 160	63 75 90 110 125 140 160 200
Nhiệt độ hàn lớn nhất/ Heating Plate Max. Temp.	270°C	
Nhiệt độ bề mặt/ Temp. Deviation un Surface	≤±5°C	
Điện áp/Working Voltage	220V 50HZ	
Công suất tấm gia nhiệt/ Heating Placte Power	1.0KW	1.6KW
Công suất máy cắt bề mặt/ Plan tool power	0.71KW	
Tổng công suất/ Total power	1.71KW	2.31KW
Áp lực ép/ Pressure Adjustable Ranges	0-6.3MPa	
Trọng lượng/ Weight	40KG	45KG
Khối lượng/ Volume	0.15M'	0.15M'

MÁY HÀN ĐIỆN TRỞ

Size: 20-315, Công suất: 3,5 kw



PHỤ KIỆN ỐNG HDPE
BẢNG PHƯƠNG PHÁP SÉT ĐOÀNG
DI PP COMPRESSION FITTING

VAN NHỰA DÙNG CHO
ỐNG HDPE & PPR
PLASTIC BALL VALVE

MÁY MẶT CHÌM & HỘP ĐÓNG HỒ
PLASTIC WATER VALVE COVER &
WATER METER BOX

BÀI KHI THỬ CHO ỐNG
UPVC & HDPE
UPVC & HDPE CLAMP SAMPLE

PHỤ KIỆN HÀN ĐỐI ĐẦU HDPE
PE BUT FUSION FITTING

PHỤ KIỆN HÀN ĐIỆN TRỞ
ELECTROFUSION FITTING DEVICES

PHỤ KIỆN HÀN LỖNG
SOCKET JUNE SERIES

MÁY HÀN
DI BUTT FUSION WELDING MACHINE

ỐNG HDPE CÁP/TRƯỢT
HDPE PIPE CAP/TRIPLAT

VAN CÔNG GANG
PHỤ KIỆN GANG

ĐỒNG HỒ NƯỚC

ỐNG GÂY XOÁN
HDPE LƯƠN ĐIỆN



MÁY HÀN CƠ ĐẨY TAY
BUTT FUSION WELDING MACHINE

Tính năng/ Brief: Dùng để hàn ống và phụ kiện nhựa PE, PP/Suitable for welding of plastic pipes and fittings made from PE, PP
Chất liệu/ Material: Nhôm/ Aluminum

THÔNG SỐ KỸ THUẬT/ SPECIFICATION

Loại/Model	AP160M-B2	AP200M-B2
Biên độ hàn/ Welding Range (mm)	63 75 90 110 125 140 160	63 75 90 110 125 140 160 200
Nhiệt độ hàn lớn nhất/ Heating Plate Max. Temp.	270°C	
Nhiệt độ bề mặt/ Temp. Deviation un Surface	≤±5°C	
Điện áp/Working Voltage	220V 50HZ	
Công suất tấm gia nhiệt/ Heating Plate Power	1.0KW	1.6KW
Công suất máy cắt bề mặt/ Plan tool power	0.71KW	
Tổng công suất/ Total power	1.71KW	2.31KW
Áp lực ép/ Pressure Adjustable Ranges	0-6.3MPa	
Trọng lượng/ Weight	40KG	45KG
Khối lượng/ Volume	0.15M'	0.15M'



MÁY HÀN M1 ĐIỀU KHIỂN NHIỆT BẰNG RƠLE
WELDING MACHINE M1



MÁY HÀN M5
WELDING MACHINE M5

THÔNG SỐ KỸ THUẬT/ SPECIFICATION

Biên độ hàn/ Fusing Pipper Scope	φ 63MM -160MM
Điện áp/ Rated Voltage	220/230V, 50/60Hz
Tổng công suất/ Power	1800W
Biên độ nhiệt độ hàn/ Environment Temperature	260°C ± 3%
Nhiệt độ môi trường/Plan tool power	-5°C - 45°C
Chất liệu sử dụng/ Applicable Material	PP-R
Trọng lượng máy/Weight Of machine	57 kg
Số lượng thùng carton Pcs/carton	01
Kích thước/ Carton Size	800x600x500 (mm)
Danh sách linh kiện/ Including the flowing accessories	
	01 máy hàn/ 01 pc fushion tool
	01 hộp kim loại/ 01 pc metal case
	01 giá đỡ máy/ 01 pc underpin rack
	01 bộ ốc vít/ 01 bag of bolt and hex key wrench
	Sockets 75, D90, D110 (optional)

OD (mm)	Hot melt depth (mm)	Heating Time (S)	Welding Time (S)	Cool-down Time(S)
20	14	5	4	3
25	16	7	4	3
32	20	8	4	4
40	21	12	6	4
50	22.5	18	6	5
63	24	24	6	6
75	26	30	10	8
90	32	40	10	8
110	38.5	50	15	10

ỐNG HDPE CẤP / THOÁT

I. ỐNG HDPE GÂN XOẮN DÙNG CHO HỆ THỐNG THOÁT

Hãng ống: Tiền Phong, Bình Minh, Đạt Hòa, Tân Long,...

Ống HDPE 1 vách



Ống gân xoắn HDPE 2 vách (dùng cho thoát nước)



Ống gân xoắn 2 lớp



II. ỐNG HDPE TRƠN DÙNG CHO HỆ THỐNG CẤP, THOÁT NƯỚC

Hãng ống: Bình Minh, Hoa Sen, Đệ Nhất, Đạt Hòa

Ống cấp



Ống HDPE trơn dùng cho cấp nước



Ống PVC Bình Minh, Hoa Sen, Tiền Phong, Đệ Nhất, Minh Hùng....



Ống HDPE các hãng Bình minh, Hoa sen, Tiền phong, Đệ nhất, Minh Hùng



ỐNG PE 100

PE 100 PIPE

Quy cách Item DN	Chiều dài ống Legth of pipe l (mm)	Chiều dày ống PE100 ($\delta_s = 8.0$ Mps) Wall thickness e (mm)					
		PN6	PN8	PN10	PN12.5	PN16	PN20
16	300	-	-	-	-	-	2.0
20	300	-	-	-	-	2.0	2.3
25	300	-	-	-	2.0	2.3	3.0
32	200	-	-	2.0	2.4	3.0	3.6
40	150	-	2.0	2.4	3.0	3.7	4.5
50	100	2.0	2.4	3.0	3.8	4.6	5.6
63	50	2.5	3.0	3.8	4.7	5.8	7.1
75	50	2.9	3.6	4.5	5.6	6.8	8.4
90	25	3.5	4.3	5.4	6.7	8.2	10.1
110	6	4.2	5.3	6.6	8.1	10.0	12.3
125	6	4.8	6.0	7.4	9.2	11.4	14.0
140	6	5.4	6.7	8.3	10.3	12.7	15.7
160	6	6.2	7.7	9.5	11.8	14.6	17.9
180	6	6.9	8.6	10.7	13.3	16.4	20.1
200	6	7.7	9.6	11.9	14.7	18.2	22.4
225	6	8.6	10.8	13.4	16.6	20.5	25.2
250	6	9.6	11.9	14.8	18.4	22.7	27.9
280	6	10.7	13.4	16.6	20.6	25.4	31.3
315	6	12.1	15.0	18.7	23.2	28.6	35.2
355	6	13.6	16.9	21.7	26.1	32.2	39.7
400	66	15.3	19.1	23.7	29.4	36.3	44.7
450	6	17.2	21.5	26.7	33.1	40.9	50.3
500	6	19.1	23.9	29.7	36.8	45.4	55.8
560	6	-	-	33.2	41.2	50.8	62.5
630	6	-	-	37.4	46.3	57.2	70.3
710	6	-	-	42.1	52.2	64.5	79.3
800	6	-	-	47.4	58.8	72.6	89.2
900	6	-	-	53.3	66.2	81.7	-
1000	6	-	-	59.3	72.5	90.2	-
1200	6	-	-	67.9	88.2	-	-

Chiều dài của ống có thể thay đổi theo yêu cầu của khách hàng
The length of the pipes can be changed to meet customer's demand

ỐNG HDPE CÁP/THUẬT

VÁN CÔNG GĂNG
PHỤ KIỆN GĂNG

BÔNG HỒ NƯỚC

ỐNG GÂY XOÀN
HDPE LƯỚI ĐIỆN



VAN CÔNG GANG, PHỤ KIỆN GANG



Khớp nối mềm BE



Khớp nối EE



Khớp nối BF



Khớp nối FF



Khớp nối BB



Thập BBBB



Thập FFFF



Côn thu FF



Khớp nối FB



Tê FFF



Tê BBB



Khủy FF



PHỤ KIỆN NỐI ỐNG HDPE
BẢNG PHƯƠNG PHÁP SÉT GỐI
BY PP COMPRESSION FITTING

VẠN NHƯA ĐỒNG CHO
ỐNG HDPE & PPR
PLASTIC BALL VALVE

NẬP VẠN TỶ CHỈN & HỘP ĐỒNG HỒ
PLASTIC WATER METER COVER &
WATER METER BOX

ĐAI KHỐI THUY CHỈN ỐNG
UPVC & HDPE
UPVC & HDPE CLAMP SADDLE

PHỤ KIỆN HÀN ĐỐI ĐẦU HDPE
PE BUTT FUSION FITTING

PHỤ KIỆN HÀN ĐIỆN TRỞ
ELECTRICAL FUSION FITTING SERIES

PHỤ KIỆN HÀN LỒNG
SOCKET JOINT SERIES

MÁY HÀN
BY BUTT FUSION WELDING MACHINE

ỐNG HDPE CẤP/THOÁT

VẠN CÔNG GANG,
PHỤ KIỆN GANG

ĐỒNG HỒ NƯỚC

ỐNG GÂY XỐN
HDPE LƯỚI ĐIỆN



Đồng hồ tổng



Đồng hồ nước thải



Đồng hồ đo lưu lượng nước

ĐỒNG HỒ NƯỚC

ỐNG GÂN XOẮN HDPE LUỒN ĐIỆN



Loại ống đường kính danh định Pipe size Nominal Diameter	Đường kính ngoài Outer diameter (mm)	Đường kính trong Inner diameter (mm)	Độ dày thành ống Wall thickness (mm)	Bước ren Pitch (mm)	Độ dài cuộn tiêu chuẩn mỗi cuộn Standard coil length (mm)	Bán kính uốn tối thiểu Min. Bending radius (mm)	Chiều cao và đường kính ngoài của cuộn ống Standard height and outer diameter of a coil (m)
TFP Ø 32/25	32 ± 2,0	25 ± 2,0	1,5 ± 0,3	1,5 ± 0,3	100 - 200	90	1,0 x 0,50
TFP Ø 43/30	40 ± 2,0	30 ± 2,0	1,5 ± 0,3	10 ± 0,5	100 - 200	100	1,2 x 0,50
TFP Ø 50/40	50 ± 2,0	40 ± 2,0	1,5 ± 0,3	13 ± 0,8	100 - 200	150	1,5 x 0,60
TFP Ø 65/50	65 ± 2,5	50 ± 2,5	1,7 ± 0,3	17 ± 1,0	50 - 100	200	1,6 x 0,60
TFP Ø 85/65	85 ± 3,0	65 ± 3,0	2,0 ± 0,3	21 ± 1,0	50 - 100	250	1,7 x 0,65
TFP Ø 90/72	90 ± 3,0	72 ± 3,0	2,1 ± 0,3	22 ± 1,0	50 - 100	270	1,7 x 0,65
TFP Ø 105/80	105 ± 3,0	80 ± 3,0	2,1 ± 0,3	25 ± 1,0	50 - 100	300	1,7 x 0,65
TFP Ø 110/90	110 ± 4,0	90 ± 4,0	2,1 ± 0,3	25 ± 1,0	50 - 100	350	1,9 x 0,75
TFP Ø 130/100	130 ± 4,0	100 ± 4,0	2,2 ± 0,4	30 ± 1,0	50 - 100	400	2,0 x 0,85
TFP Ø 160/125	160 ± 4,0	125 ± 4,0	2,4 ± 0,4	38 ± 1,0	50 - 100	400	2,4 x 1,00
TFP Ø 195/150	195 ± 4,0	150 ± 4,0	2,8 ± 0,4	45 ± 1,5	30 - 50	500	2,5 x 1,20
TFP Ø 210/160	200 ± 4,0	160 ± 4,0	3,0 ± 0,5	50 ± 1,5	30 - 50	550	2,5 x 1,40
TFP Ø 230/175	230 ± 4,0	175 ± 4,0	3,5 ± 1,0	55 ± 1,5	30 - 50	600	2,6 x 1,70
TFP Ø 260/200	260 ± 4,0	200 ± 4,0	4,0 ± 1,5	60 ± 1,5	30 - 50	750	2,8 x 1,80
TFP Ø 320/250	320 ± 4,0	250 ± 4,0	4,0 ± 1,5	60 ± 1,5	20 - 30	850	2,8 x 1,80

HÌNH ẢNH ĐIỂM HÌNH MỘT SỐ DỰ ÁN ĐÃ CẤP



HÌNH ẢNH ĐIỂM HÌNH MỘT SỐ DỰ ÁN ĐÃ CẤP



BỘ PHỤ KIỆN KẾT NỐI ỐNG HDPE DÙNG TRONG HỆ THỐNG CẤP NƯỚC



“CHẤT LƯỢNG TẠO NÊN THƯƠNG HIỆU”

CÔNG TY TNHH SẢN XUẤT THƯƠNG MẠI NHỰA CHÂU ÂU

Địa chỉ: Số 68/8A Trần Tấn, Phường Tân Sơn Nhì, Quận Tân Phú, TP. HCM
MST: 0315 206 597

Điện thoại: 028 3849 3888

Email: ketoan.nhuachauau@gmail.com

Website: www.daikhoithuy.com - mayhanthuyluchdpe.com

Hotline: 0903 17 00 09